



Ningbo Longlive was founded in 1980, covering an area of 30,000 square meters. We are specialized in manufacturing brass fittings and valves, exported to Europe, America, South America, Australia, Japan, Dubai, etc. There is the whole set of equipment of forging, stamping, casting, machining, polishing, plating, PVD and testing machines.

Since 2008 Longlive has been focusing on LEAD FREE products due to California State Law AB1953. We can produce



Spectrographic analysis



Roughness Comparison



Laser



Salt spray test



SPECIAL THREAD CMC MACHINE



Three coordinate measuring



Screw gauge



Hardness Tester



Thickness gauge



Vernier Caliper



Gauge



ANGLE VALVE SERIES

Ningbo Longlive Brass Co., Ltd www.llbrass.com

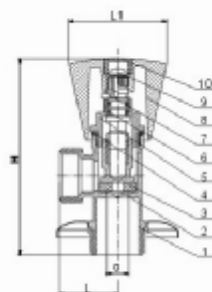

LL-80001

BRASS ANGLE VALVE
WITH FLANGE AND LONG NUT

Temperature: min 0° C
max +80° C
Nominal Pressure: max 10bar
Size: from 1/2"

| Ø | L | L1 | H |
|------|------|----|----|
| 1/2" | 22.5 | 39 | 74 |

| NO. | Component | Material |
|-----|-------------|----------|
| 1 | Body | Brass |
| 2 | Cartridge | Brass |
| 3 | Seal Gasket | NBR |
| 4 | Stem | Brass |
| 5 | O-Ring | NBR |
| 6 | O-Ring | NBR |
| 7 | Gasket | Brass |
| 8 | Handle | Zinc |
| 9 | Screw | Brass |
| 10 | Button | Plastic |

ANGLE VALVE SERIES

Ningbo Longlive Brass Co., Ltd www.llbrass.com



LL-80003

BRASS ANGLE VALVE
WITH FLANGE AND LONG NUT

Temperature: min 0° C
max +80° C
Nominal Pressure: max 10bar
Size: from 3/8" 1/2" OD to 1/2"x1/2"

| ØH | 1/2"x3/8" OD | 1/2"x1/2" |
|----|--------------|-----------|
| A | 86 | 86 |
| B | 23.5 | 25 |
| C | 8 | 8 |

| NO. | Component | Material |
|-----|-----------------|-----------------|
| 1 | Handle | Plastic |
| 2 | Stem | Brass |
| 3 | Press nut | Brass |
| 4 | O-ring | NBR |
| 5 | Rubber gasket | NBR |
| 6 | Body | Brass |
| 7 | Accessory cover | Stainless steel |
| 8 | Olive | P.T.F.E |
| 9 | Nut | Brass |

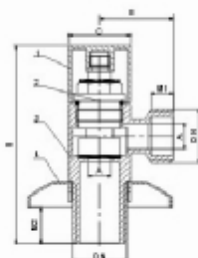
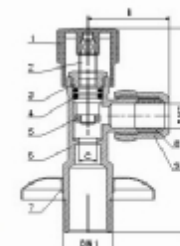

LL-80002

HEXANGULAR ANGLE VALVE

Temperature: min 0° C
max +90° C
Nominal pressure: max 10bar
Available: 1/2"x1/2"

| ØH | 1/2"x1/2" |
|-------|-----------|
| A | 9 |
| B | 77.5 |
| C | 26.5 |
| M1/M2 | 8/15 |
| E | 27 |

| NO. | Component | Material |
|-----|--------------|-----------------|
| 1 | Handle wheel | Brass |
| 2 | Core | Brass |
| 3 | Body | Brass |
| 4 | Cover | Stainless Steel |

LL-80004

1. Nominal Pressure: 1.5Mpa
2. Working Temperature: -20°C ≤ t ≤ 150°C
3. Thread: ISO 228/1-2000
4. Suitable Medium: Water
5. Chrome plated

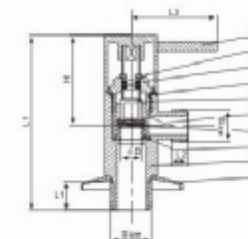

| No. | Component | Material |
|-----|-------------------|-----------------|
| 1 | Accessory Rosette | Stainless Steel |
| 2 | Body | Brass |
| 3 | Seat Ring | NBR |
| 4 | Cartridge | Ceramic |
| 5 | Stem | Brass |
| 6 | Bonnet | Brass |
| 7 | O-Ring | NBR |
| 8 | O-Ring | NBR |
| 9 | Washer | Copper |
| 10 | Handle Wheel | Brass |

| SIZE | ØD | L | L1 | L2 | L3 | H |
|-----------|----|----|----|----|----|----|
| 1/2"x3/8" | 10 | 77 | 19 | 10 | 42 | 39 |
| 1/2"x1/2" | 10 | 77 | 19 | 10 | 42 | 39 |



ANGLE VALVE SERIES

Ningbo Longlive Brass Co., Ltd. www.llbrass.com

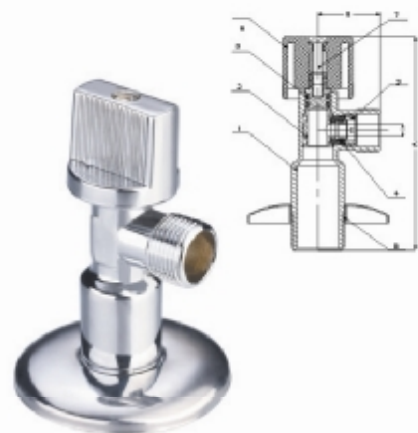

LL-80005

BRASS ANGLE VALVE
WITH FLANGE AND LONG NUT
Temperature: min 0°C
max +80°C
Nominal Pressure: max 10bar
Size: from 1/2"x3/8" OD to 1/2"x1/2" 1/2"x1/2"

| DN | 1/2"x3/8" | 1/2"x1/2" | 1/2"x1/2" |
|----|-----------|-----------|-----------|
| A | 75 | 80 | 100 |
| B | 25 | 25 | 25 |
| C | 8 | 8 | 8 |

| NO. | Component | Material |
|-----|------------------|-----------------|
| 1 | Body | Brass |
| 2 | Stem | Brass |
| 3 | Pressnut | Brass |
| 4 | Gasket | Black rubber |
| 5 | O-ring | NBR |
| 6 | Handle | Plastic |
| 7 | Cross screw | Steel |
| 8 | Decorative cover | Stainless steel |

ANGLE VALVE SERIES

Ningbo Longlive Brass Co., Ltd. www.llbrass.com

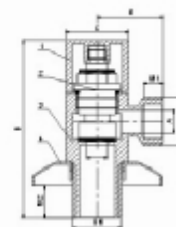

LL-80007

FOUR SQUARE ANGLE VALVE
Temperature: min 0°C
max +90°C
Nominal pressure: max 10bar
Available: 1/2"x1/2"



| DN | 1/2"x1/2" |
|-------|-----------|
| A | 9 |
| B | 76 |
| C | 24 |
| M1/M2 | 8.5/1.5 |
| E | 28.5 |

| NO. | Component | Material |
|-----|--------------|-----------------|
| 1 | Handle wheel | Brass |
| 2 | Core | Brass |
| 3 | Body | Brass |
| 4 | Cover | Stainless steel |

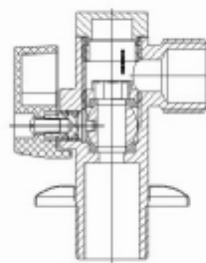

LL-80006

BRASS ANGLE BALL VALVE
WITH FLANGE STAINLESS STEEL CAP, CHROMED
Temperature: min 0°C
max +80°C
Nominal Pressure: max 10bar
Available: from 1/2"x3/8" up to 1/2"x1/2"

| DN | 1/2"x3/8" | 1/2"x1/2" |
|----|-----------|-----------|
| A | | |
| B | | |
| C | | |

LL-80008

BRASS ANGLE BALL VALVE
WITH FLANGE STAINLESS
STEEL CAP, CHROMED
Temperature: min 0°C
max +80°C
Nominal Pressure: max 10bar
Available: from 1/2"x1/2" up to 1/2"x3/4" 1/2"x3/8"

| DN | 1/2"x1/2" | 1/2"x3/4" | 1/2"x3/8" |
|-------|-----------|-----------|-----------|
| A1/A2 | 9.5 | 9.5 | |
| B | 30.5 | 30.5 | |
| C | 34.5 | 34.5 | |
| E | 38.5 | 38.5 | |
| M1/M2 | 13/1.2 | 12 | |
| F | 47 | 47 | |

| NO. | Component | Material |
|-----|-----------------|-----------------|
| 1 | Body | Brass |
| 2 | Seat | P.T.F.E |
| 3 | Ball | Brass |
| 4 | O-ring | NBR |
| 5 | Stem | Brass |
| 6 | Handle | Plastic |
| 7 | Screw | Brass |
| 8 | Accessory cover | Stainless Steel |
| 9 | Valve nut | Brass |

